

Delivering leading edge, innovative power solutions for more than 30 years....

Model:GTM961200P120VV.V-T3

May 10, 2021

GlobTek's GTM961200 series of external tabletop/desktop power supplies offer up to 120W of power while offering compliance to the latest ITE, Medical, Household, and Efficiency requirements.

Information

Model Number	GTM961200P120VV.V-T3
Description	120 W, DoE Level VI & CoC Tier 2 Efficiency, Three Prong (C14) Inlet, Desktop Adapter, Ac-Dc Power Supply

Model Picture

Agency Documents	http://www.globtek.info/certs/GTM961200P/
CE EC-Declaration	https://www.globtek.com/pdf/ec_declaration/a0Oa000000MjJKDEA3
RoHS/RoHS2 Declaration	https://www.globtek.com/pdf/rohs_cert/a0Oa000000MjJKDEA3
REACH Declaration	https://www.globtek.com/pdf/iso_certificates/REACH.pdf
Conflict Minerals Declaration	https://www.globtek.com/pdf/conflict-minerals.pdf

Delivering leading edge, innovative power solutions for more than **30** years....

Model:GTM961200P120VV.V-T3

May 10, 2021

MODEL PARAMETERS

Type	Desktop/External
Technology	Regulated Switchmode AC-DC Power Supply AC Adaptor
Category	ICT / ITE / Medical Power Supply
Input Voltage	100-240V~, 50-60 Hz
I/P Amps (A)	1.5 A
Wattage (W)	120.0
Vout Range (V)	12-54
Efficiency Level	USA DOE Level VI / Eco-design Directive 2009/125/EC, (EU) 2019/1782
Ingress Protection	IP41
Size (mm)	149.30*62.80*34.00

PROPRIETARY INFORMATION

PROPRIETARY OF GLOBTEK, INC. ANY REPRODUCTION, DISCLOSURE OR USE OF THIS DRAWING, IN WHOLE OR IN PART, IS HEREBY PROHIBITED EXCEPT AS SPECIFIED IN WRITING BY GLOBTEK, INC.

<https://en.globtek.com/datasheet/id/a0Oa000000MjJKD>

Delivering leading edge, innovative power solutions for more than 30 years....

Model:GTM961200P120VV.V-T3

May 10, 2021

ENCLOSURE

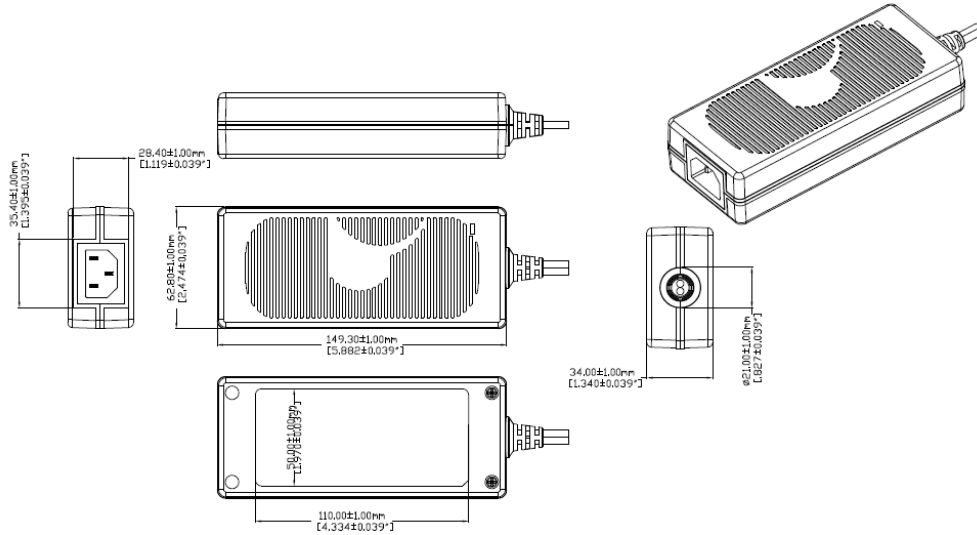

Alternative housing with input cord clamp to prevent accidental removal of the power cord. Product PN# ends with suffix "CL"

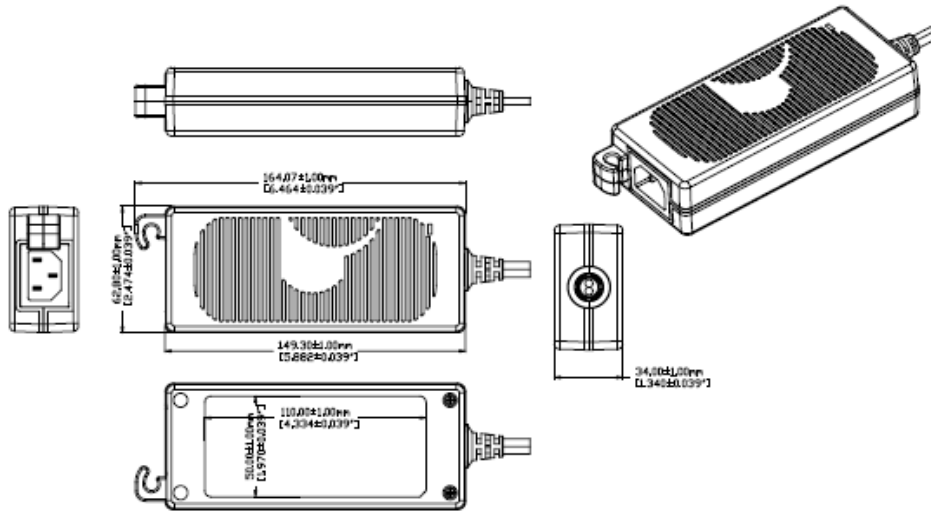

Delivering leading edge, innovative power solutions for more than **30** years....

Model:GTM961200P120VV.V-T3

May 10, 2021

RATING TABLE

Model Number	Voltage	Amps(A)	Watts(W)	RFQ
GTM961200P11012-T3	12 V	9.2	110.40	RFQ
GTM961200P10812-T3	12 V	9	108.00	RFQ
GTM961200P12015-T3	15 V	8	120.00	RFQ
GTM961200P10019-T3	19 V	5.263	100.00	RFQ
GTM961200P12019-T3	19 V	6.316	120.00	RFQ
GTM961200P12024-T3	24 V	5	120.00	RFQ
GTM961200P12028-T3	28 V	4.28	119.84	RFQ
GTM961200P12030-T3	30 V	4	120.00	RFQ
GTM961200P12036-T3	36 V	3.33	119.88	RFQ
GTM961200P12038-T3	38 V	3.15	119.70	RFQ
GTM961200P12048-T3	48 V	2.5	120.00	RFQ
GTM961200P12054-T3	54 V	2.22	119.88	RFQ

Model:GTM961200P120VV.V-T3

May 10, 2021

SPECIFICATIONS

A) ELECTRICAL SPECIFICATIONS:

01. Input Voltage: Specified 90-264 Vac, Nameplate rated: 100-240Vac
 - 90-264Vac range @ 100% of rated load current
 - 85-264 Vac range @ 90% of rated load current
 - 90-370 VDC range @ 100% of rated load current
02. Input Frequency: Specified 47-63 Hz, Nameplate rated 50/60Hz
03. Power Factor: 0.90 minimum @ 230Vac, 0.97 minimum @ 115Vac
04. Output Regulation: +/- 4% measured at the output connector
05. Line Voltage Regulation: +/- 0.5% typical measured at full load
06. Green Power On Indicator LED
07. Output Ripple (Vp-p): 1% or 200 mV whichever is greater, measured at 20 MHz bandwidth with 0.1uF ceramic capacitor in parallel with a low impedance 47uF electrolytic capacitor connected at the end of the output connector at nominal line
08. Turn-ON/OFF Overshoot: 5% maximum, 1 ms typical recovery time for 25% to 50% step load
09. Turn-ON Delay: 1 second typical
10. Hold-Up Time: 20 ms minimum
11. Inrush Current: 65A maximum at 115Vac input and 130A maximum at 230 Vac input
12. Switching Frequency: Varies from 25KHz to 125KHz
13. Efficiency: Compliant with Efficiency Level VI standard and 230 CoC Tier 2 Limits
14. No Load Standby Power: <0.15 W @ 230Vac

B) PROTECTIONS

01. Input Protection: Input line fusing and 300Vac rated MOV
02. Short Circuit/ Overload: Electronically Protected unit will auto recover upon removal of fault
 - Output Current Limit: Current limited to less than 170W / Vnom and 13A
 - (Vnom = nominal rated output voltage)
03. Over-Temperature : Latching Electronic Overtemperature protection. Cycle AC OFF to reset.
04. Output Over-Voltage: 110% to 135% of nominal output voltage under full load condition, and less than 60V max. Latching protection, cycle AC OFF to reset.

C) SAFETY

01. Dielectric Withstand Voltage: 4000Vac or 5656Vdc from input to output,
 - On Class I models, 3000Vac or 4242Vdc from input to earth
02. Earth Leakage Current: Class I models < 300uA, N/A for Class II models
03. Touch Current: Class I models < 20uA, Class II models < 70uA
04. Output Isolation Options:
 - a) C8 or C18 Inlet, Class II
 - b) C6 or C14 Inlet, Class II FE, Output Isolated from Earth contact
 - c) C6 or C14 Inlet, Class I, Output negative directly attached to Earth contact
05. Earth Continuity Test: < 0.1 Ohm between Earth Pin at AC input and PCB termination point (Class I models only)
06. Means of Protection: 2 x MOPP
07. Primary to Secondary Bridging Capacitance: Two IEC60384-14 certified Y1 type capacitors in series
08. Compliant Standards: See listings at end of this drawing for specifics

D) EMC

EN 60601-1-2, 4th edition

PROPRIETARY INFORMATION

PROPRIETARY OF GLOBTEK, INC. ANY REPRODUCTION, DISCLOSURE OR USE OF THIS DRAWING, IN WHOLE OR IN PART, IS HEREBY PROHIBITED EXCEPT AS SPECIFIED IN WRITING BY GLOBTEK, INC.

<https://en.globtek.com/datasheet/id/a0Oa000000MjJKD>

Delivering leading edge, innovative power solutions for more than 30 years....

Model:GTM961200P120VV.V-T3

May 10, 2021

Emissions, per EN 55032, EN 61000-6-3, EN 61000-6-4, CISPR11 and CISPR22

Conducted Emissions: Class B, FCC Part 15, Class B

Radiated Emissions: Class B, FCC Part 15, Class B

Line Frequency Harmonics EN61000-3-2, Class A

Voltage Fluctuations/Flicker EN61000-3-3

Immunity, per EN 55024, EN 61000-6-1, EN 61000-6-2

Static Discharge Immunity EN61000-4-2, 10KV Contact Discharge, 18KV air discharge

Radiated RF Immunity EN61000-4-3, 10V/m 80-1000MHz, 3V/m 1-2.7GHz, 80% 1KHz AM.

EFT/Burst Immunity EN61000-4-4, 4KV/100kHz.

Line Surge Immunity EN61000-4-5, 2KV differential, 4kV common-mode

Conducted RF Immunity EN61000-4-6, 3Vrms, 80% 1KHz AM

Power Frequency Magnetic Field Immunity EN61000-4-8, 3A/m

Voltage Dip Immunity EN61000-4-11

E) OTHER:

01. 1,500,000 hours @ 25°C ambient, full load (Telcordia SR-332, Issue 3)

02. Operating Temperature:

GTM961200P Family: -10°C to 40°C ambient temperature with full load

Regarding Operating Temperature,

a- See below derating table for output power capability at alternate temperature

b- Extended low end temperature range available as custom option

03. Humidity: 0% to 95% relative humidity, non-condensing

04. Storage Temperature: -30°C to 80°C

05. Cooling: Natural convection

06. RoHS: Compliant with latest regulations, see approvals section below

07. Operational Altitude: 5000M

F) DESKTOP STYLE ENCLOSURE

01. Housing: High impact plastic, 94V0 polycarbonate, non-vented

02. Size: 149.4 x 62.6 x 33.5 +/-1.0 mm

03. Markings: Label or Laser printed

04. AC Input mechanical options: Desktop C6, C8, C14 or C18 IEC Inlet.

G) SPECIAL OPTIONS

01. Custom cord-sets, cord types, and connector types

02. Custom markings/logos

03. Custom housing and cord-set colors

04. Reduced output power marking/rating

05. Short term output surge capability

06. Reduced leakage current version for Type-CF leakage current

07. Improved output voltage tolerance

08. Reduced output voltage ripple

09. Improved EN61000-4-5 line surge immunity (3KV differential, 5KV common-mode)

10. Reduced harmonic current levels for LED lighting (EN61000-3-2 Class C, from 85W to 120W output)

11. Improved reliability PCB laminate with plated through-holes for IPC610 Class 2 compliance

12. Low temperature operation, down to -40°C

13. Epoxy potted version, "P2" or "P3" suffix, with flying wires

PROPRIETARY INFORMATION

PROPRIETARY OF GLOBTEK, INC. ANY REPRODUCTION, DISCLOSURE OR USE OF THIS DRAWING, IN WHOLE OR IN PART, IS HEREBY PROHIBITED EXCEPT AS SPECIFIED IN WRITING BY GLOBTEK, INC.

<https://en.globtek.com/datasheet/id/a0Oa000000MjJKD>

Delivering leading edge, innovative power solutions for more than **30** years....

Model:GTM961200P120VV.V-T3

May 10, 2021

- 14. Tolerance for back EMF applications, motor loads, or other high inductance reverse energy flow requirements
- 15. Improved ingress protection (IP) rating

H) OUTPUT CONNECTORS

Several output connector options are available with various output current ratings.

GlobTek can supply 10A rated 2.1mm and 2.5mm style DC Power Jacks, to complement our

10A output rated 2.1mm and 2.5mm DC power plugs used on our output cordsets.

Please visit <https://en.globtek.com/news/high-current-coaxial-barrel-plug-jacks-for-high-wattage-power-supplies> for a real time product offering of mating connectors.

Delivering leading edge, innovative power solutions for more than 30 years....

Model:GTM961200P120VV.V-T3

May 10, 2021

DERATING CURVE

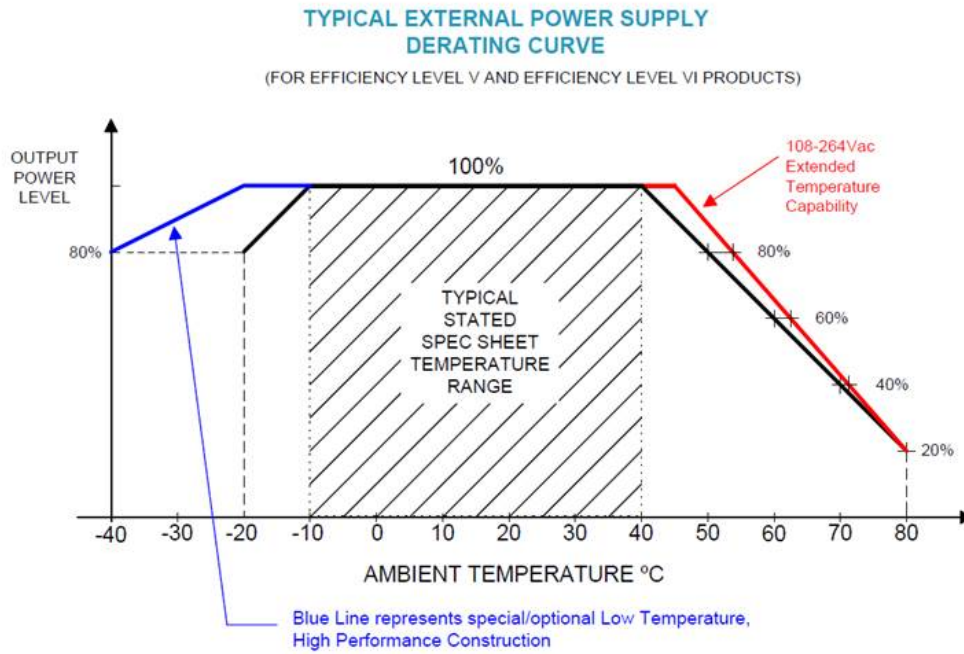

Delivering leading edge, innovative power solutions for more than 30 years....

Model:GTM961200P120VV.V-T3

May 10, 2021

INPUT CONFIGURATION

Description IEC 60320/C14 AC Inlet Connector, Class I, Earth Ground

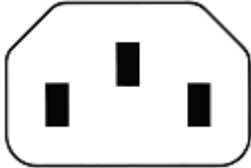

Mates with IEC 60320/C13 Plug

Optional Locking IEC60320 Receptacle and cord option available on some models by request.:

[Standard International IEC 320/C13 Cordsets](#)

Below are standard cordsets which are "not included" (unless stated above); these can be purchased separately or packaged with the power supply. Contact your Sales Engineer if the style required is not shown below. Many more available in different lengths, colors or cable material.

Stock Power Supply Cords

Part Number/ Link	Country	Plug	Termination	Length (mm)	(Ft)
3021457F701(R)	N. American (Type B)	NEMA 5-15P	IEC 320/C13	2150	7
1191068F0701(R)	N. American (Type B)	NEMA 5-15P Hospital	IEC 320/C13	2459	8
2194272M5701-T(R)	Argentina (Type I)	IRAM 2073	IEC 320/C13	2500	8
5502022M5701A(R)	Australian (Type I)	AS3112 / 3 PRONG	IEC 320/C13	2500	8
204B4272M5701(R)	Brazil (Type N)	BRAZIL	IEC 320/C13	2500	8
6023602M5701(R)	China (Type I)	CCC GR2099	IEC 320/C13	2500	8
G8014272M5701(R)	Danish (Type K)	AFSNIT SECTION 107-2-D1	IEC 320/C13	2500	8
23144272M5701-T(R)	Europe (Type E)	CEE 7/7	IEC 320/C13	2500	8
205IN4272M5701(R)	India (Type D)	India IS 1293 (also known as IA16A3 or BS546)	IEC 320/C13	2500	8
208IN4272M5701(R)	India (Type M)	India IS 1293 (also known as IA16A3 or BS546)	IEC320/C13	2500	8
377C4272M5701(R)	Israel (Type H)	ISL 377C	IEC 320/C13	2500	8
23024272M5701(R)	Italy (Type L)	CEI 23-16/VII	IEC 320/C13	2500	8
3003339F701(R) [3x1.25mm2]	Japan (Type B)	JIS 8303 / 3 PINS	IEC 320/C13	2500	8

PROPRIETARY INFORMATION

PROPRIETARY OF GLOBTEK, INC. ANY REPRODUCTION, DISCLOSURE OR USE OF THIS DRAWING, IN WHOLE OR IN PART, IS HEREBY PROHIBITED EXCEPT AS SPECIFIED IN WRITING BY GLOBTEK, INC.

<https://en.globtek.com/datasheet/id/a0Oa000000mjKD>

Delivering leading edge, innovative power solutions for more than **30** years....

Model:GTM961200P120VV.V-T3

May 10, 2021

3003068F2701-HK(R) [3 x 2.0mm2]					
302J115J6F0701J(R)	Japan / North America (Type B – 12A)	JIS 8303 / 3 PINS and NEMA 5-15P (PSE and UL/CUL appr)	IEC 320/C13	1830	6
302J104J6F0701J(R)	Japan / North America (Type B – 15A)	JIS 8303 / 3 PINS and NEMA 5-15P (PSE and UL/CUL appr)	IEC 320/C13	1830	6
2313K3432M5701(R)	Korea (Type F)	KS C 8305	IEC 320/C13	2500	8
5804272M5701(R)	Russia (Type F)	GOST 7396	IEC 320/C13	2500	8
2084272M5701(R)	South Africa (Type M)	South Africa SABS164-1 (16A type)	IEC 320/C13	2500	8
23214272M5701(R)	Switzerland (Type J)	SEV 1011	IEC 320/C13	2500	8
3003322M5701(R)	Taiwan (Type B)	BSMI	IEC 320/C13	2500	8
PZ0800100-2M5BK13H(R)	UK, Hong Kong, Singapore, Gulf States (Type G)	BS 1363A	IEC 320/C13	2500	8
7055002M5701A(R)	International	IEC 320 C14-C13	IEC 320/C13	2500	8

Delivering leading edge, innovative power solutions for more than 30 years....

Model:GTM961200P120VV.V-T3

May 10, 2021

OUTPUT CONFIGURATION

Common output connector options:

 L Type (Coaxial
5.5x2.5mm plug)

 C Type (Coaxial
5.5x2.1mm plug)

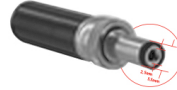
 K Type (Coaxial
3.5x1.3mm plug)

 LL Type (5.5x2.5mm
Locking 760k type)

 CL Type (5.5x2.1mm
Locking S761k type)

 ML2 Type (Molex
housing 43025-0200)

 YL3 Type
(KPPX-3P)

YL4 Type (KPPX-4P)

 EJ1/2/3/4/5 (EIAJ
RC-5320A type
connectors)

 MSB Type (Micro
USB)

 USBC Type (USB
Type C)

 Inquire for custom
design

 For a comprehensive list of options, [click here](#)



Contact GlobTek for your specific requirements or custom solutions.

Delivering leading edge, innovative power solutions for more than 30 years....

Model:GTM961200P120VV.V-T3

May 10, 2021







Approvals

Logo	Description
	Taiwan BSMI GTM961200P-T3(A) R32282 GTM961200P-T3(A); http://www.bsmi.gov.tw/wSite/ct?xItem=4072&ctNode=8167=2
No Logo Applicable	CB for IEC 60950-1:2005 (Second Edition) + Am 1:2009 + Am 2:2013
No Logo Applicable	CB for IEC 60601-1:2006/A1:2013+A12:2014 IEC 60601-1-11:2015
No Logo Applicable	CB for IEC 60335-1:2010 (Fifth Edition) incl. Corr. 1:2010 and Corr. 2:2011 + A1:2013
No Logo Applicable	IEC 60335-1.2010+A1
No Logo Applicable	CB for IEC61347-1:2015 + A1:2017 IEC61347-2-13:2014, A1:2016
No Logo Applicable	CB for IEC 62368-1:2014 (Second Edition)
	CCC Altitude up to 5000 m GB17625.1-2012, GB4943.1-2011, GB/T9254-2008
	Test standard: EN 55032: 2012+AC: 2013 EN 61000-3-2:2014 EN 61000-3-3:2013 EN 55024:2010 EN 60601-1-2:2015
	Audio/Video, Information And Communication Technology Equipment - Part 1: Safety Requirements [UL

Delivering leading edge, innovative power solutions for more than 30 years....

Model:GTM961200P120VV.V-T3





May 10, 2021

	62368-1:2014 Ed.2] Audio/Video, Information And Communication Technology Equipment - Part 1: Safety Requirements [CSA C22.2#62368-1:2014 Ed.2]
	CHINA SJ/T 11364-2014, China RoHS Chart: http://en.globtek.com/globtek-rohs.php
Conforms to AAMI STD.ES60601-1,IEC 60601-1-11 Certified to CAN/CSA STD.C22.2 NO.60601-1	Conforms to AAMI STD.ES60601-1,IEC 60601-1-11 Certified to CAN/CSA STD.C22.2 NO.60601-1
Conforms to UL STD. 60950-1 Certified to CSA STD C22.2 NO.60950-1	Conforms to UL STD. 60950-1 Certified to CSA STD C22.2 NO.60950-1
Conforms to UL STD. 62368-1 Certified to CSA STD C22.2 NO.62368-1	Conforms to UL STD. 62368-1 Certified to CSA STD C22.2 NO.62368-1
	Declaration ДС № EAЭC N RU Д-US.KA01.B.10453_19 Custom Union of Russia, Belarus and Kazakhstan http://www.globtek.com/redirect/?loc=gost-certificate-eac-declaration
	Medical Electrical Equipment - Part 1: General Requirements For Basic Safety And Essential Performance (R2012) [AAMI ES60601-1:2005 +C1;A2] [CSA C22.2#60601-1:2014 Ed.3] [AAMI HA60601-1-11:2015 Ed.2]
	Information Technology Equipment Safety Part 1: General Requirements >Valid without technical revision: 01Jan2022< [UL 60950-1:2007 Ed.2 +R:14Oct2014]
	Indoor Use Only - Mark is on the label or Molded in the case
 DC-E-G71-005.1 PRECAUCION: PARA USO EN	IRAM certificate DC-E-G71-005.1 to IEC 62368-1:2014

Delivering leading edge, innovative power solutions for more than 30 years....

Model:GTM961200P120VV.V-T3

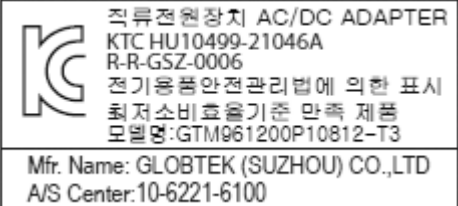







May 10, 2021

EQUIPOS ELECTRONICOS SOLAMENTE	
 GlobTek, Inc.	JAPAN TUV R-PSE, Cert. No. JD 50469658, to J62368-1(H30) , J55032(H29),J3000(H25)[15V or less]. Please reference the following website for guidelines on PSE regulations: http://en.globtek.com/importing-ite-and-medical-power-supplies-ac-adaptors-to-japan/
 GlobTek, Inc.	JAPAN TUV R-PSE, Cert. No. JD 50469658, to J62368-1(H30) , J55032(H29),J3000(H25)[DC15?30V]. Please reference the following website for guidelines on PSE regulations: http://en.globtek.com/importing-ite-and-medical-power-supplies-ac-adaptors-to-japan/
 GlobTek, Inc.	JAPAN TUV R-PSE, Cert. No. JD 50469658, to J62368-1(H30) , J55032(H29),J3000(H25)[DC30?60V]. Please reference the following website for guidelines on PSE regulations: http://en.globtek.com/importing-ite-and-medical-power-supplies-ac-adaptors-to-japan/
 <p> 직류전원장치 AC/DC ADAPTER KTC HU10499-21046A R-R-GSZ-0006 전기용품안전관리법에 의한 표시 최저소비효율기준 만족 제품 모델명:GTM961200P10812-T3 Mfr. Name: GLOBTEK (SUZHOU) CO.,LTD A/S Center:10-6221-6100 </p>	Korea KET KC Mark GTM961200P11012-T3(A) HU10499-21046A (12V & 13V Only)
 <p> 직류전원장치 AC/DC ADAPTER KTC HU10499-9002A 최저소비효율기준 만족 제품 모델명:GT-41062-1812-T3 Mfr. Name: GLOBTEK (SUZHOU) CO.,LTD A/S Center: 10-6211-6100 </p>	Korea KET KC Mark GTM961200P12024-T3 HU10499-9002A (24V Only) pending
EFFICIENCY LEVEL VI	Efficiency: complies to section 301 of Energy Independence and Security Act (EISA) complies with Energy Star tier 2 (North America), ECP tier 2 (China), MEPS tier 2 (Australia), Code of Conduct (Europe)
No Logo	Malaysia ST Release Letter GTM41133 GTM96900P; GTM961200P T2 T3(A) IEC60950-1(Ed.2): 2005 + A1:2009 + A2:2013 No logo
	Morocco SDoC declaration http://www.globtek.info/certs/Morocco%20SDoC%20Declaration/

Delivering leading edge, innovative power solutions for more than 30 years....

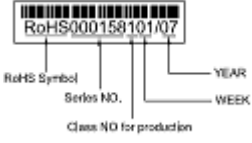
Model:GTM961200P120VV.V-T3

May 10, 2021

	NOM MEXICO -ANCE FOR GTM961200P-T3 12,15,18,19,24,36,48 and 54V only
	Natural Resources Canada (NRCAN): CSA Standard C381.1-08, QSP NRCAN EEV1191; http://shop.csa.ca/en/canada/energy-efficiency/canca-c3811-08/invt/27024802008
	RCM certificate SAA-170646-EA; Australia and New Zealand Regulatory Compliance, Mark (http://rcm.standards.org.au/rcmfaq/rcmfaq.htm)
RoHS	Specifications of directive 2011/65/EU Annex VI (ROHS-2) with amendment 2015/863-EU (ROHS-3) http://www.ce-mark.com/Rohs%20final.pdf
	S-Mark Certificate EN 60601-1:2006 + A1:2013 + A12:2014 EN 60601-1-11:2015 (http://www.intertek.com/marks/s/)
	S-Mark Certificate EN 60950-1:2006 + A11:2009 + A1:2010 + A12:2011+A2:2013 (http://www.intertek.com/marks/s/)
	S-Mark Certificate EN 62368-1:2014 + A11 (http://www.intertek.com/marks/s/)
	Serial Number Information
	UKCA Certification
	Ukraine UKRSepr (Document: www.globtek.com/html/iso_certificates/GT_Ukraine.pdf)
	Japan: Voluntary Control Council for Interference (VCCI)

Delivering leading edge, innovative power solutions for more than **30** years....

Model:GTM961200P120VV.V-T3

May 10, 2021

	<p>WEEE: Complies with EU 2012/19/EU (http://ec.europa.eu/environment/waste/weee/index_en.htm) Mark is on the label or Molded in the case</p>
---	--